

(Consultant Logo)

Drawing Title

SERVICE SHEET

(Drawing Informations from Consultant)

SAMPLES

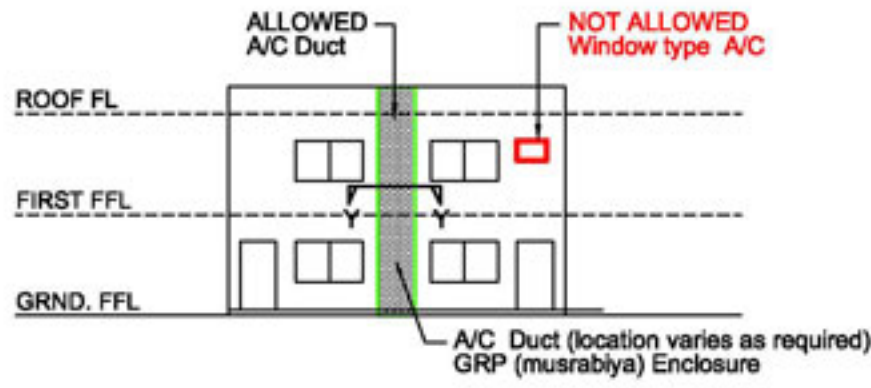

MAIN / FRONT ELEVATION
(Villas, Flats & High Rise Buildings)

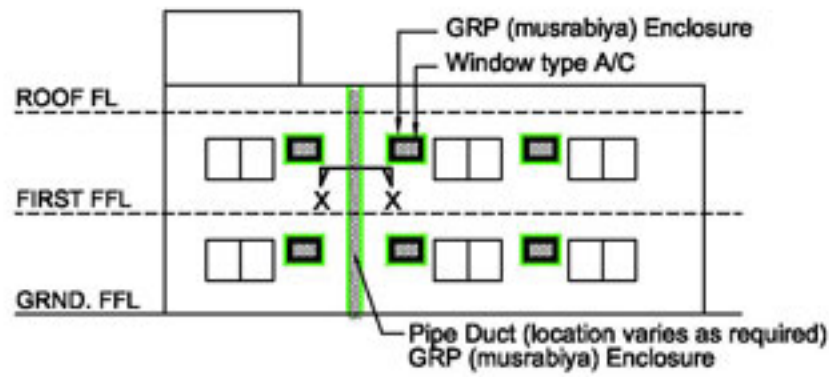

REAR, LEFT & RIGHT SIDE ELEVATION
(Allowed for Villas, Flats & High Rise Buildings)

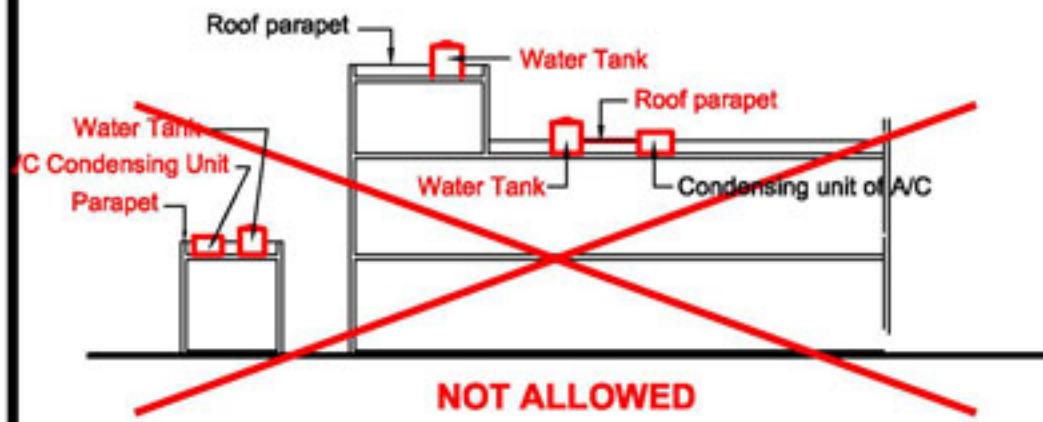

NOT ALLOWED

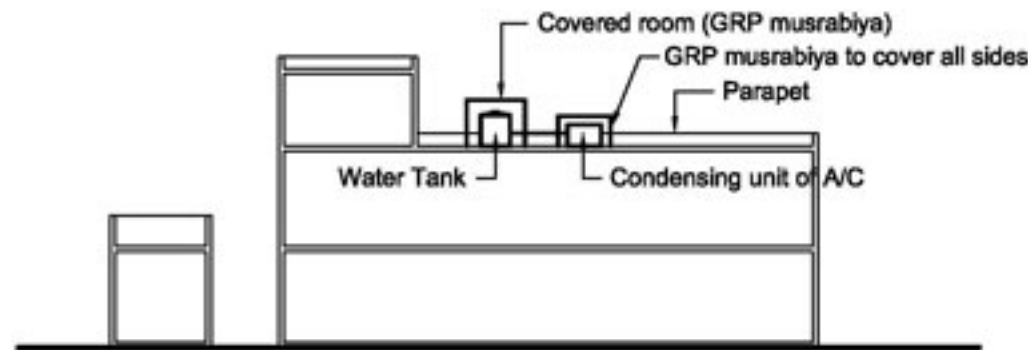

ALLOWED

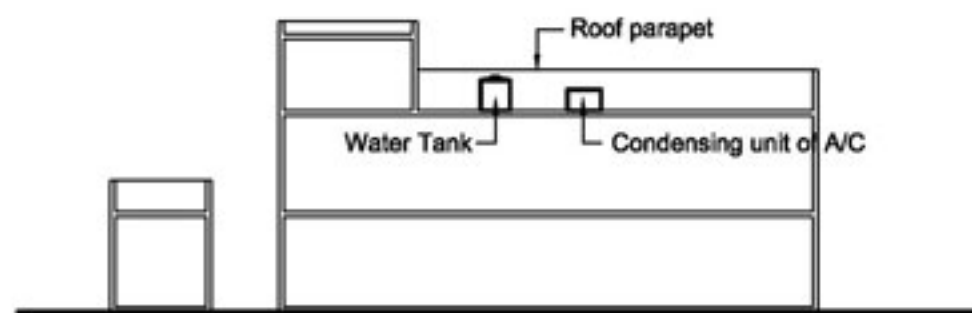

ALLOWED

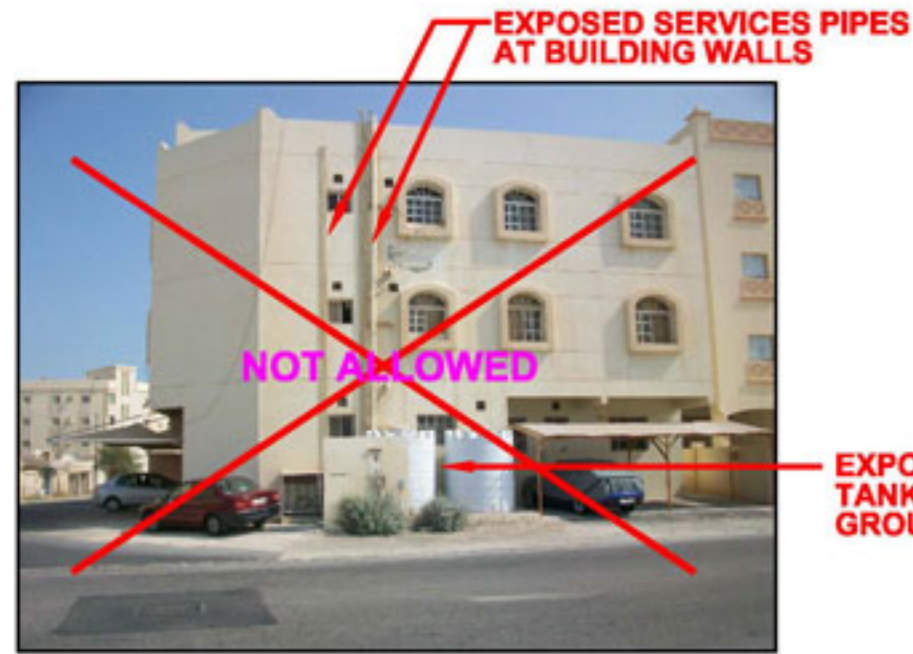

EXPOSED SERVICES PIPES AT BUILDING WALLS



EXPOSED WATER TANKS AT GROUND LEVEL

EXPOSED WATER TANKS AT ROOF LEVEL

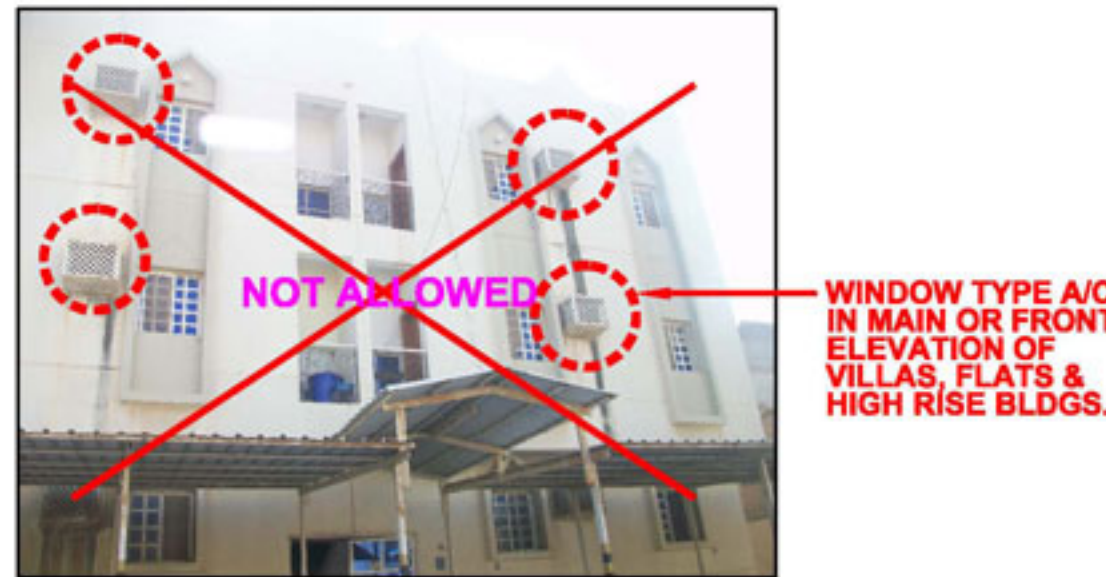

WINDOW TYPE A/C IN MAIN OR FRONT ELEVATION OF VILLAS, FLATS & HIGH RISE BLDGS.

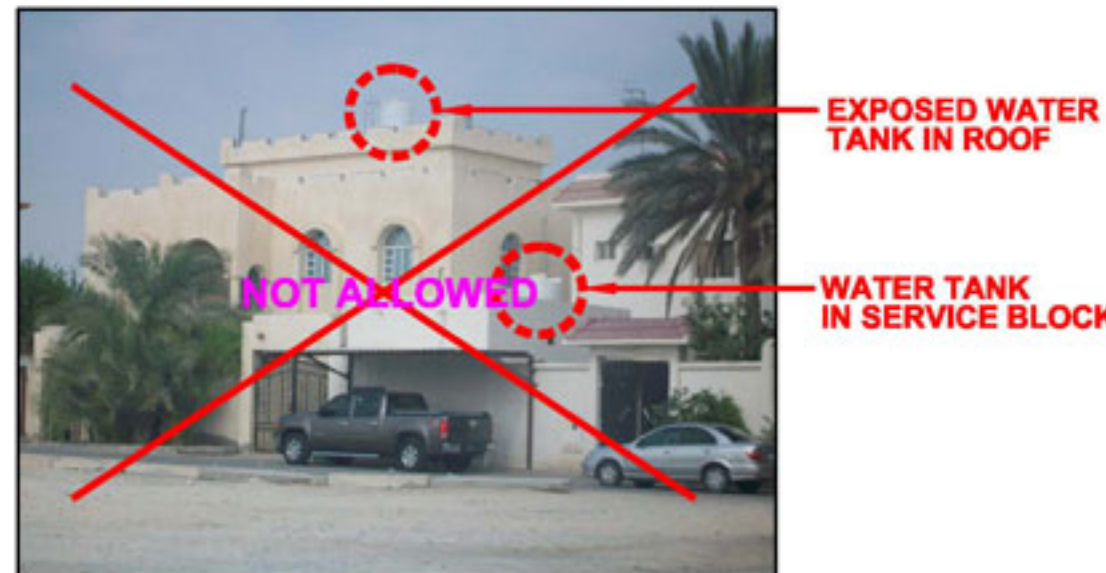

EXPOSED WATER TANK IN ROOF

WATER TANK IN SERVICE BLOCK

DETAILS

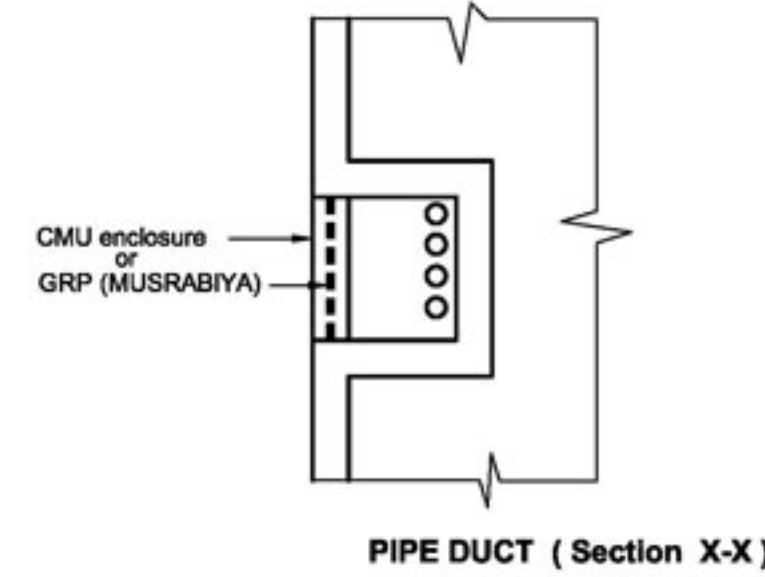

PIPE DUCT (Section X-X)

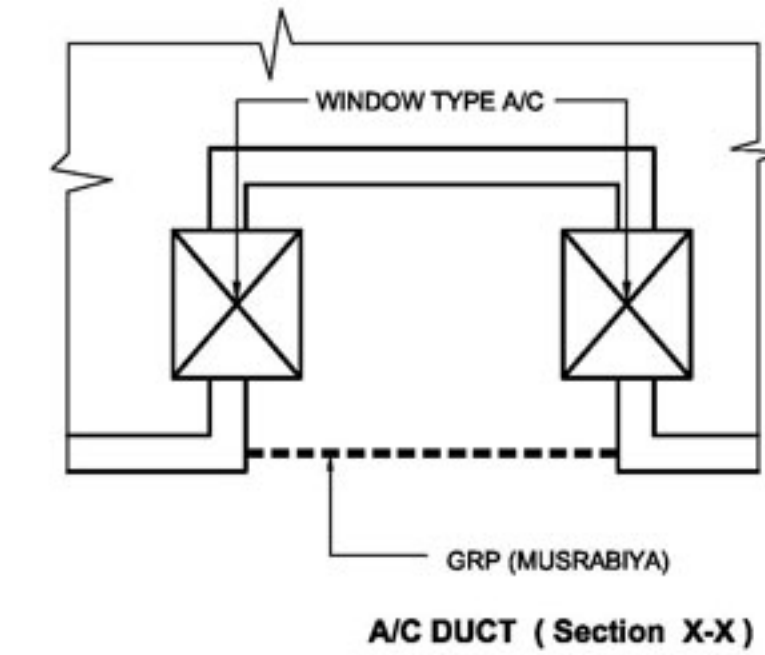

A/C DUCT (Section X-X)

DETAILS OF METER PANELS FOR VILLAS ONLY

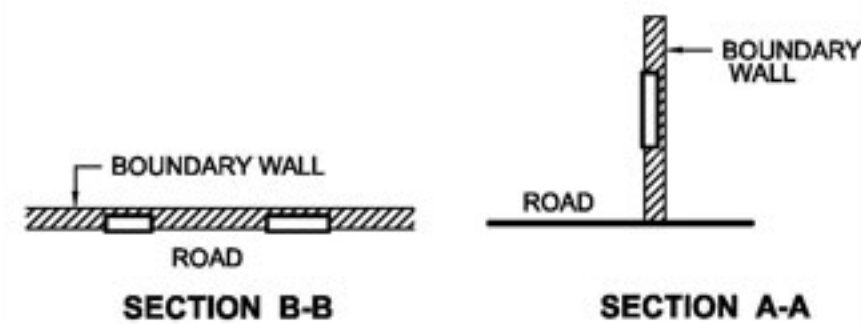
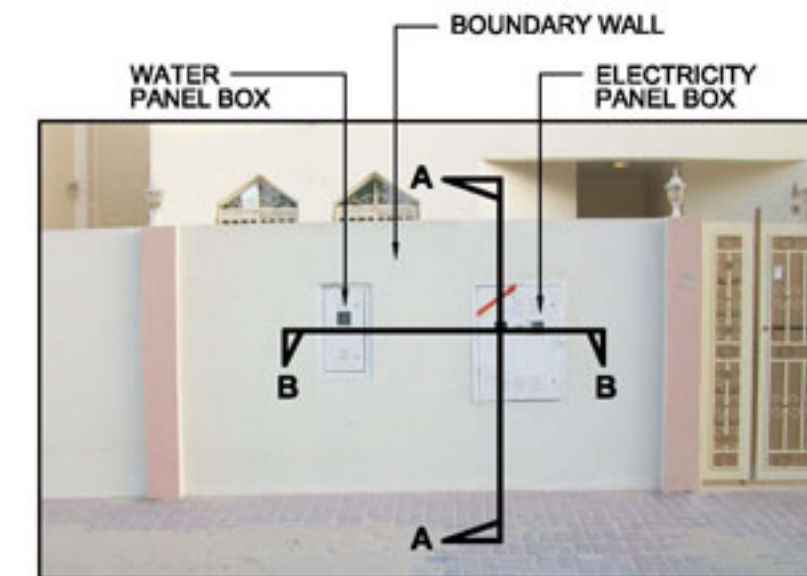

(Consultant Logo)

Drawing Title

SERVICE SHEET

(Drawing Informations from Consultant)

ALLOWED



FIRE WATER INSTALLATION FOR FLATS & HIGH RISE BUILDINGS

NOT ALLOWED

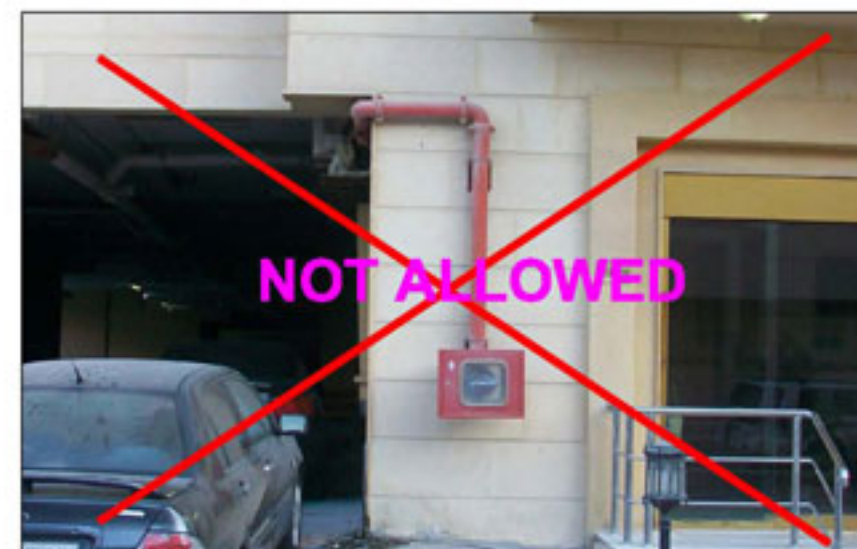

(Consultant Logo)

Drawing Title

SERVICE SHEET

(Drawing Informations from Consultant)